



# L300 LED SERIES

Suspended Linear Indirect/Direct Lighting

## DESCRIPTION

The L300 low-profile luminaire is available in both lens and baffle body styles. Configured for either individual or continuous runs, the L300 LED series offers a partially curved design with a flat underside providing a great choice for those looking to add a more aesthetically pleasing, high end look to their finished lighting projects specifying solid function and appealing form.

## SPECIFICATIONS

- Housing: 20 gauge cold-rolled steel construction.
- Lengths: 4' and 8' fixtures that can also be joined to make long rows.
- Finish: Durable, low gloss, textured powder coated finish.
- End Caps: Flat end cap provides a clean finish.
- Approvals: UL/CUL.
- LED Engine: ULT dimming driver and LED board combination.
- Optional Drivers: Lutron, Osram, EldoLED & other options available.
- Distribution: Standard 80/20 with optional distributions available.
- Optic: Available in Lens or Flush Baffle.
- Output Package: High, Very High, and Super Saver lumen levels available.
- Sensor: Optional Integrated Daylight or Occupancy sensors.
- LED Color: Available color temperatures of 3000k, 3500k, and 4000k.
- Mounting: Aircraft grade cable with fully adjustable Yoke mount.
- Ceiling Type: T-bar or Hard ceiling mounting kits available.
- Battery: Optional 12 Watt Constant power Emergency Battery.
- CRI: 82+
- I.E.S. Data: Available upon request.
- Warranty: 5-Year limited warranty.



## FIXTURE OPTIONS

Ordering Example: L350-4-30-120-VHO-WHT-FF

| Fixture Series                     | Length | LED Color                              | Voltage  | Output   | Distribution Type  | Emergency Circuit   | Finish  | Integrated Sensor   | Options  |
|------------------------------------|--------|--|--|--|--|---|---|---|--|
| L350 - Lens<br>L345 - Flush Baffle | 4<br>8 | 30 - 3000K<br>35 - 3500K<br>40 - 4000K | MVO - 120-277v<br>120 - 120v<br>277 - 277v<br>347 - 347v | HO - High<br>SS - Super Saver<br>VHO - Very High | Blank - Standard<br>64 - 60% up, 40% down<br>55 - 50% up, 50% down<br>37 - 30% up, 70% down<br>28 - 20% up, 80% down | Blank - (None)<br>EF - Separate individual<br>Emergency feed<br>EHF - Emergency Through Wiring<br>with Separate Feed<br>EHS - Emergency Through Wiring<br>Single Feed with shared Neutral | WHT<br><br>* Consult<br>factory for<br>custom<br>colors | Blank - None<br>DAY - Daylight<br>OCC - Occupancy<br><br>* Consult Factory for Lutron, ELdoLED, Osram, or other Drivers | Blank - (None)<br>FF - Fast Blow Fuse<br>FS - Slow Blow Fuse<br>EB - Emergency Battery<br>EC - Emergency Circuit |

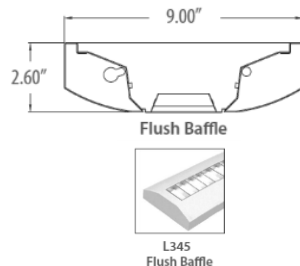
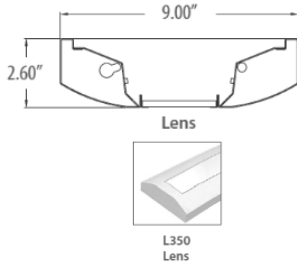

| 4' Output Package | Lumens | Watts | Lumens/Watt |
|-------------------|--------|-------|-------------|
| High (HO)         | 4480   | 44    | 101         |
| Super Saver (SS)  | 3456   | 34    | 101         |
| Very High (VHO)   | 5952   | 63    | 95          |

# L300 LED SERIES



## PHOTOMETRICS

\* Measurements based on High level output

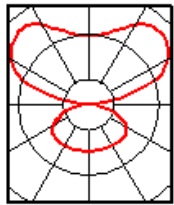

**80/20** – Standard  
4480 lumens  
82% up - 18% down  
100 lm/W

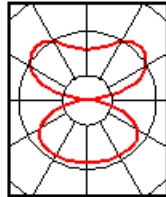

**60/40** – Option  
3815 lumens  
60% up - 40% down  
86 lm/W

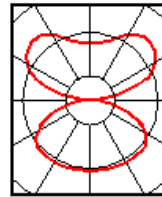

**50/50** – Option  
3623 lumens  
51% up - 49% down  
82 lm/W

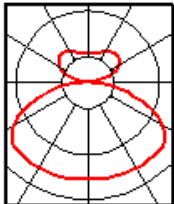

**30/70** – Option  
3450 lumens  
32% up - 68% down  
79 lm/W

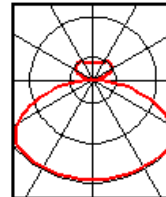

**20/80** – Option  
3310 lumens  
20% up - 80% down  
75 lm/W

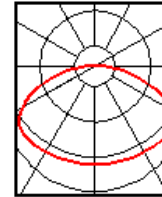

**0/100** – Option  
3134 lumens  
0% up - 100% down  
71 lm/W

## MOUNTING SUPPORT LENGTHS & FIXTURE WEIGHTS

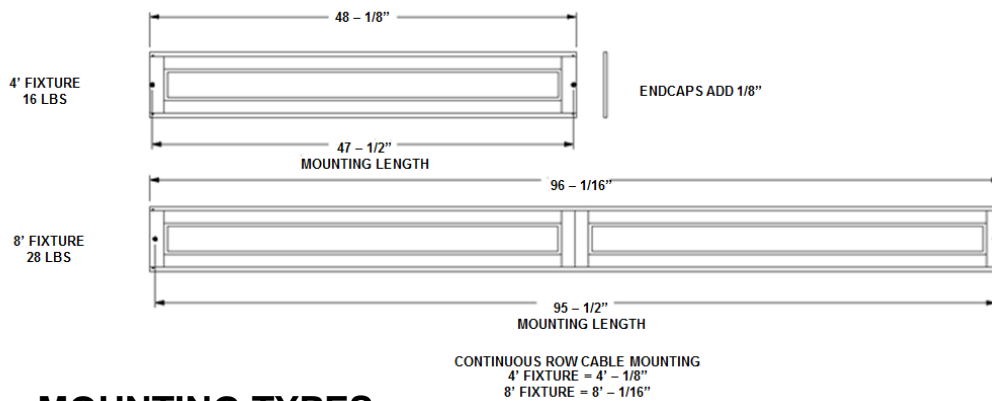

## MOUNTING TYPES

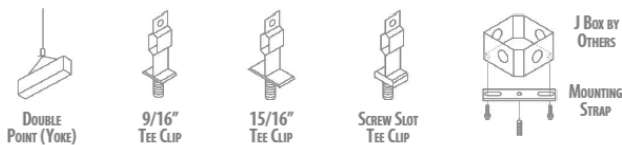

Hardware Ordering Example: SCFD-Y-15C-FA-36

| Prefix  | Fixture Attachment                                   | Ceiling Attachment  | Suspension Type      | Suspension Length   |
|---|--|---|----------------------|---|
| SCFD – Single Circuit Feed<br>Dimmable<br>ECF – Emergency Circuit Feed<br>NF – Non Power Feed | Y – Two Point<br>S – Stem Mount<br>(Consult Factory) | HC – Hard Ceiling<br>SC – Screw Slot Clip<br>15C – 15/16" Tee Clip<br>9C – 9/16" Tee Clip | FA – Fully Assembled | 18 – (24" Adjustable Cable)<br>24 – (30" Adjustable Cable)<br>36 – (42" Adjustable Cable)<br>72 – (78" Adjustable Cable)<br>144 – (150" Adjustable Cable) |

### Each Kit Comes With:

- Support clips for T-bars, OR straps for J-box, with threaded stud for cable connection
- One white canopy
- Aircraft cable
- Feed cord (except non-feed hangers)
- Fixture attachment hardware

**END CAP KIT: 300-WHT (One kit required per fixture run)**



Group Dekko  
2505 Dekko Drive, Garrett, IN 46738  
Phone: 800-829-3101  
www.dekko.com  
Rev. 11/30/2015