

# L400 LED SERIES

*Suspended Linear Indirect/Direct Lighting*

## DESCRIPTION

The L400 low-profile luminaire is available in both lens and baffle body styles. Configured for either individual or continuous runs, the L400 LED series offers a full curve design on the underside making it an excellent choice for projects requiring high function and well-designed lighting. This series provides visual appeal made specifically for applications specifying high quality lighting with a high-end look.

## SPECIFICATIONS

Housing:	20 gauge cold-rolled steel construction.
Lengths:	4' and 8' fixtures that can also be joined to make long rows.
Finish:	Durable, low gloss, textured powder coated finish.
End Caps:	Flat end cap provides a clean finish.
Approvals:	UL/CUL.
LED Engine:	ULT dimming driver and LED board combination.
Optional Drivers:	Lutron, Osram, EldoLED & other options available.
Distribution:	Standard 80/20 with optional distributions available.
Optic:	Available in Lens or Flush Baffle.
Output Package:	High, Very High, and Super Saver lumen levels available.
Sensor:	Optional Integrated Daylight or Occupancy sensors.
LED Color:	Available color temperatures of 3000k, 3500k, and 4000k.
Mounting:	Aircraft grade cable with fully adjustable Yoke mount.
Ceiling Type:	T-bar or Hard ceiling mounting kits available.
Battery:	Optional 12 Watt Constant power Emergency Battery.
CRI:	82+
I.E.S. Data:	Available upon request.
Warranty:	5-Year limited warranty.

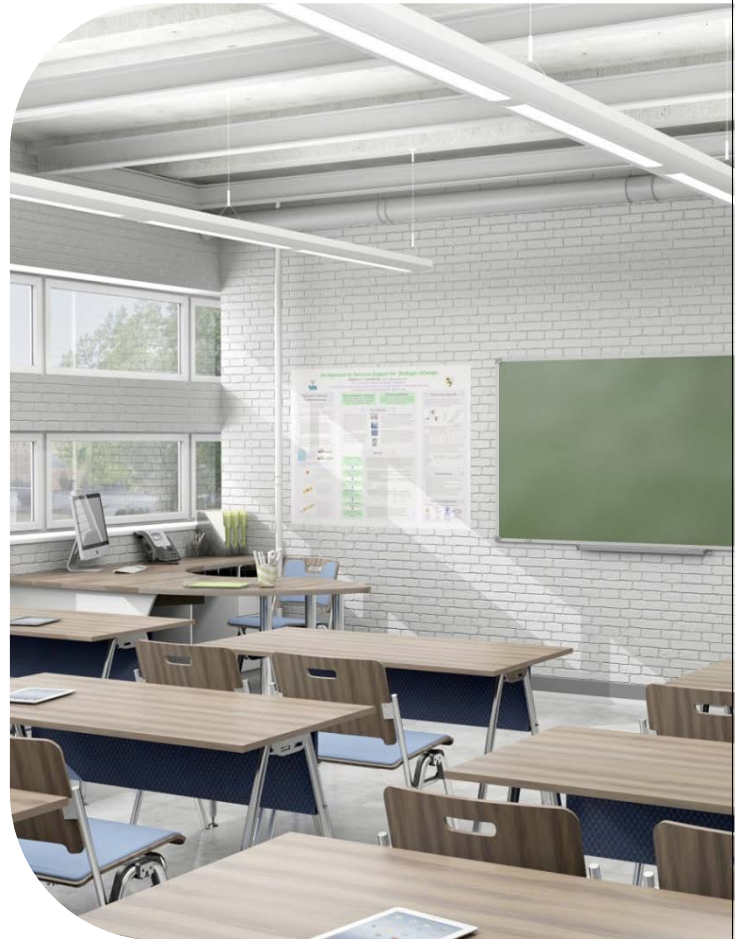

## FIXTURE OPTIONS

Ordering Example: L450-4-30-120-SS-WHT-FF

Fixture Series	Length	LED Color	Voltage	Output	Distribution Type	Emergency Circuit	Finish	Integrated Sensor	Options
L450 - Lens L445 - Flush Baffle	4 8	30 - 3000k 35 - 3500k  40 - 4000k	MVO - 120-277v 120 - 120v  277 - 277v 347 - 347v	HO - High SS - Super Saver  VHO - Very High	Blank - Standard 64 - 60% up, 40% down  55 - 50% up, 50% down 37 - 30% up, 70% down 28 - 20% up, 80% down	Blank - (None) EF - Separate individual Emergency feed EHF - Emergency Through Wiring with Separate Feed EHS - Emergency Through Wiring Single Feed with shared Neutral	WHT  Consult factory for custom colors	Blank - None DAY - Daylight  OCC - Occupancy  * Consult Factory for Lutron, ELdoLED, Osram, or other Drivers	Blank - (None) FF - Fast Blow Fuse  FS - Slow Blow Fuse  EB - Emergency Battery EC - Emergency Circuit

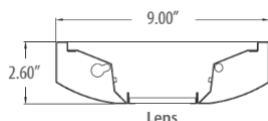

L450  
Lens

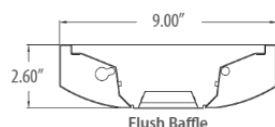

L445  
Flush Baffle

4' Output Package	Lumens	Watts	Lumens/Watt
High (HO)	4274	44	97
Super Saver (SS)	3303	34	97
Very High (VHO)	5644	63	90

# L400 LED SERIES



## PHOTOMETRICS

\* Measurements based on High level output

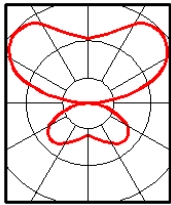

**80/20** – Standard  
4274 lumens  
82% up - 18% down  
97 lm/W

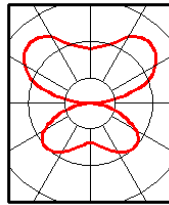

**60/40** – Option  
3615 lumens  
60% up - 40% down  
82 lm/W

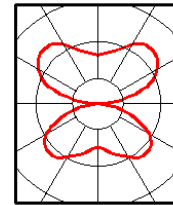

**50/50** – Option  
3428 lumens  
51% up - 49% down  
78 lm/W

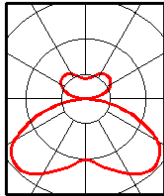

**30/70** – Option  
3255 lumens  
32% up - 68% down  
74 lm/W

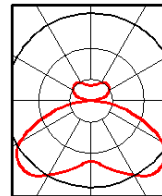

**20/80** – Option  
3115 lumens  
20% up - 80% down  
71 lm/W

## MOUNTING SUPPORT LENGTHS & FIXTURE WEIGHTS

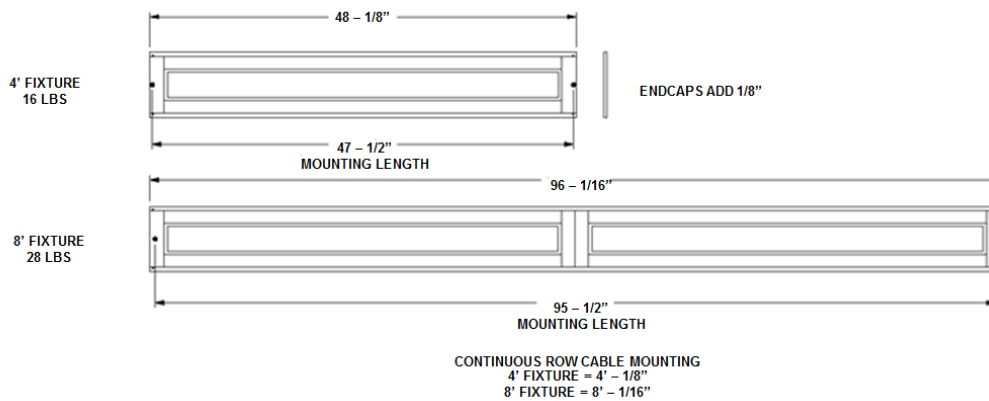

## MOUNTING TYPES

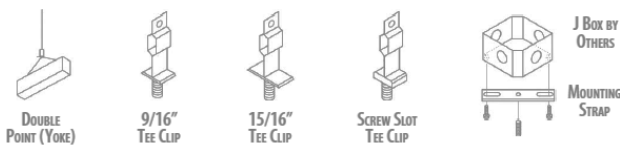

Hardware Ordering Example: SCFD-Y-15C-FA-36

Prefix	Fixture Attachment	Ceiling Attachment	Suspension Type	Suspension Length
SCFD – Single Circuit Feed Dimmable ECF – Emergency Circuit Feed NF – Non Power Feed	Y – Two Point S – Stem Mount (Consult Factory)	HC – Hard Ceiling SC – Screw Slot Clip 15C – 15/16" Tee Clip 9C – 9/16" Tee Clip	FA – Fully Assembled	18 – (24" Adjustable Cable) 24 – (30" Adjustable Cable) 36 – (42" Adjustable Cable) 72 – (78" Adjustable Cable) 144 – (150" Adjustable Cable)

### Each Kit Comes With:

- Support clips for T-bars, OR straps for J-box, with threaded stud for cable connection
- One white canopy
- Aircraft cable
- Feed cord (except non-feed hangers)
- Fixture attachment hardware

**END CAP KIT: 400-WHT (One kit required per fixture run)**



Group Dekko  
2505 Dekko Drive, Garrett, IN 46738  
Phone: 800-829-3101  
www.dekko.com  
Rev. 11/30/2015