



BY DEKKO

2505 Dekko Drive
Garrett, IN 46738
Customer Service: 800.357.5622

Powered by Pent[®] **ASHLEY TRIO⁺** - Conduit Feed - Above Worksurface Mounting Installation Instruction

This device complies with part 15A of the FCC Rules. Operation is subject to the following two conditions: (1) This device may not cause harmful interference, and (2) this device must accept any interference received, including interference that may cause undesired operation.

Tools Required

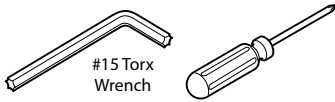

SPECIAL NOTE *

Optional data port options will need to be purchased from L-COM. L-COM part numbers have been provided in step #2.

1 Remove Data Port Cover

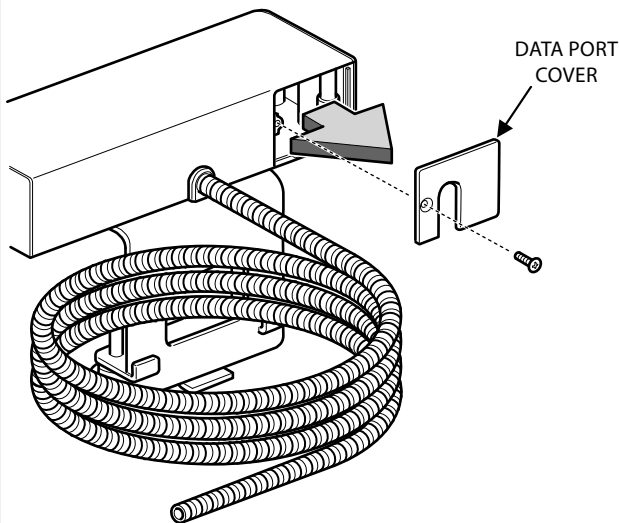

2 Install Data Port Option - (VGA,RJ45, HDMI, BLANK)

NOTE

See Sheet #2 for Detailed Instructions

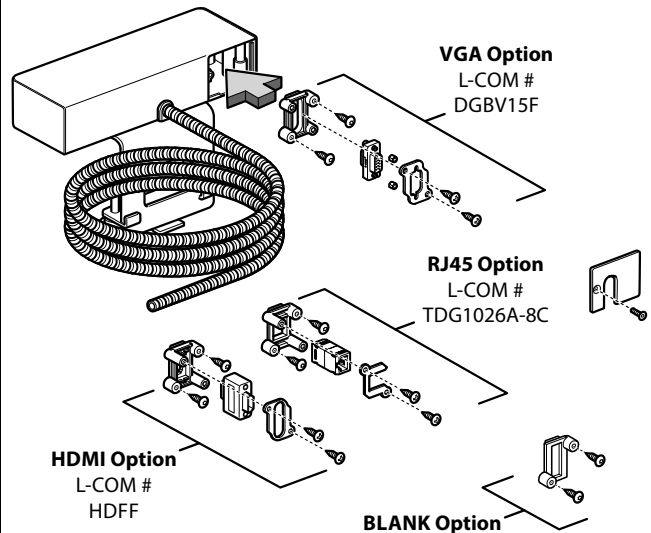

3 Slide Bracket Behind Worksurface

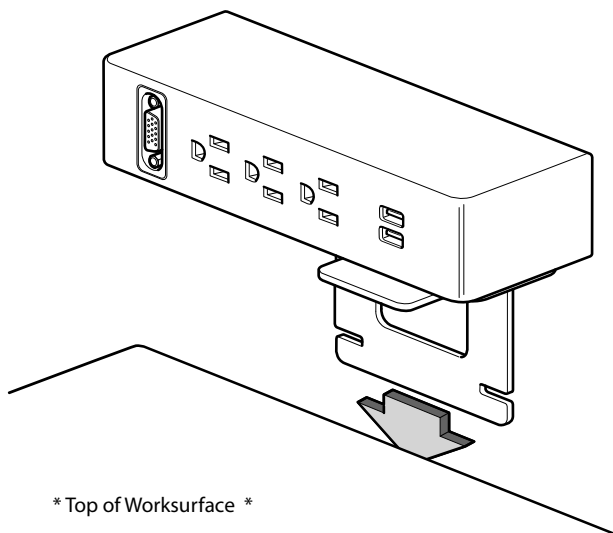

4 Install Bottom Bracket Under the Worksurface

* Underside of Worksurface *

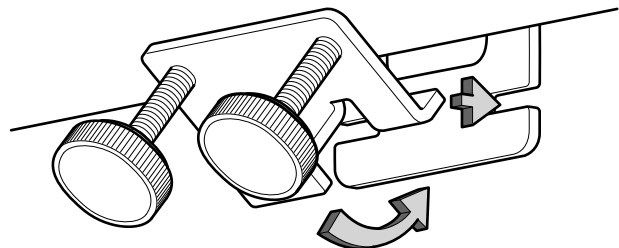



2505 Dekko Drive
Garrett, IN 46738
Customer Service: 800.357.5622

Powered by Pent®
ASHLEY TRIO⁺
- Conduit Feed -
Above Worksurface Mounting
Installation Instruction

This device complies with part 15A of the FCC Rules. Operation is subject to the following two conditions: (1) This device may not cause harmful interference, and (2) this device must accept any interference received, including interference that may cause undesired operation.

Tools Required

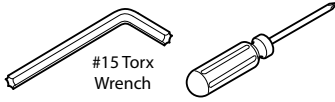

2.1 Install VGA Option (L-COM# DGBV15F)

A Remove Nuts from VGA Connector

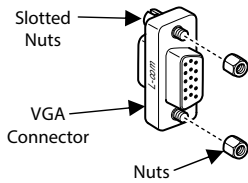

B Install Bracket to Connector

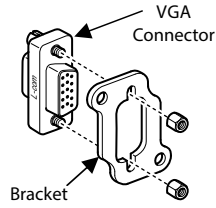

C Install Components into Body of Unit

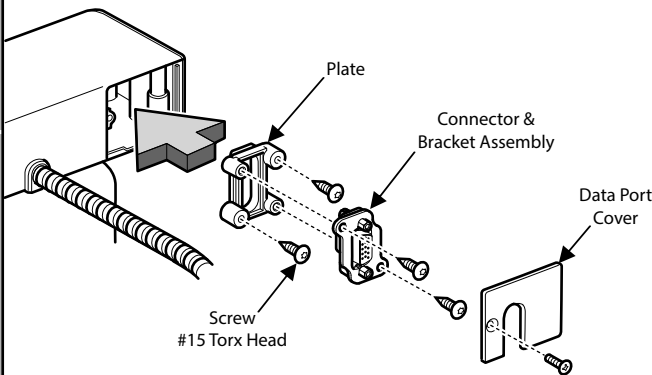

2.2 Install RJ45 Option (L-COM# TDG1026A-8C)

A Mate Angled Surfaces of Plate and Connector

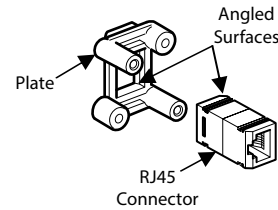

B Install Bracket

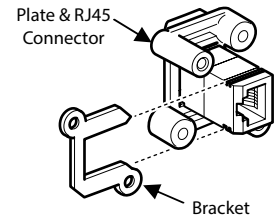

C Install Components into Body of Unit

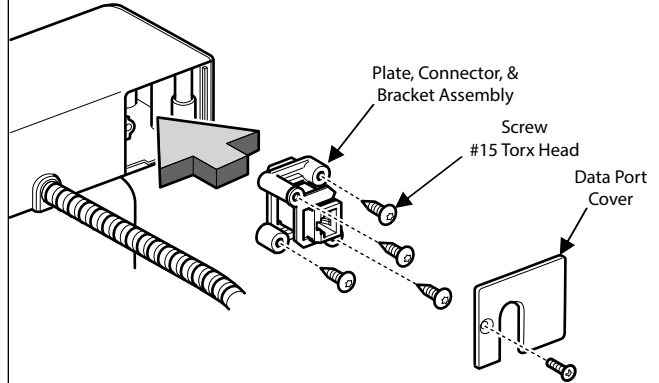

2.3 Install HDMI Option (L-COM# HDFS)

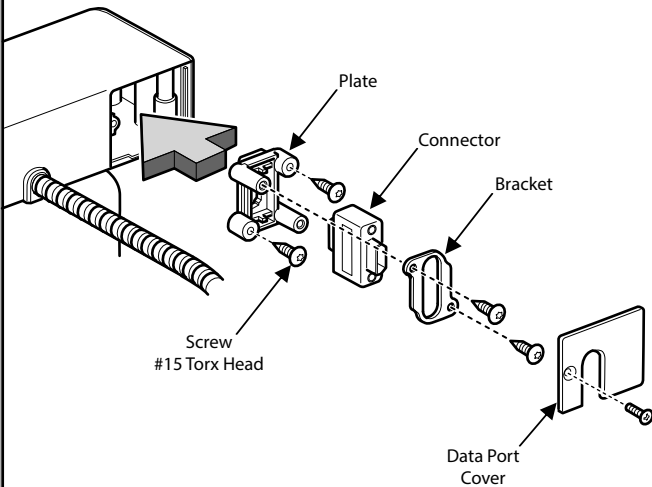

2.4 Install BLANK Option

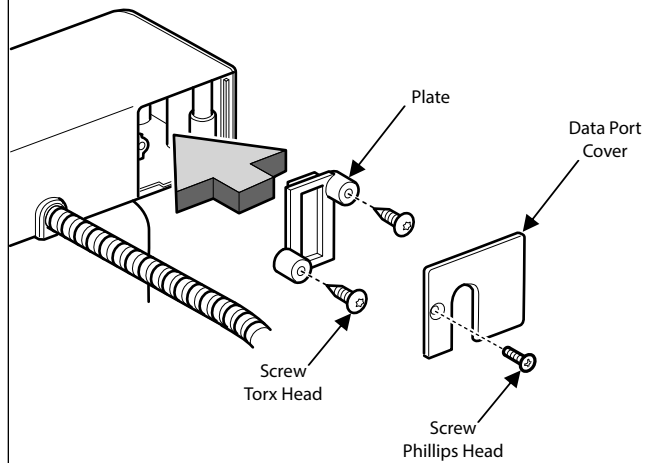



2505 Dekko Drive
Garrett, IN 46738
Customer Service: 800.357.5622

Powered by Pent®
ASHLEY TRIO⁺
- Conduit Feed -
Above Worksurface Mounting
Installation Instruction

This device complies with part 15A of the FCC Rules. Operation is subject to the following two conditions: (1) This device may not cause harmful interference, and (2) this device must accept any interference received, including interference that may cause undesired operation.

Tools Required

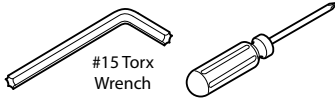

5 Route Conduit Feed to Nearest Power Distribution Source

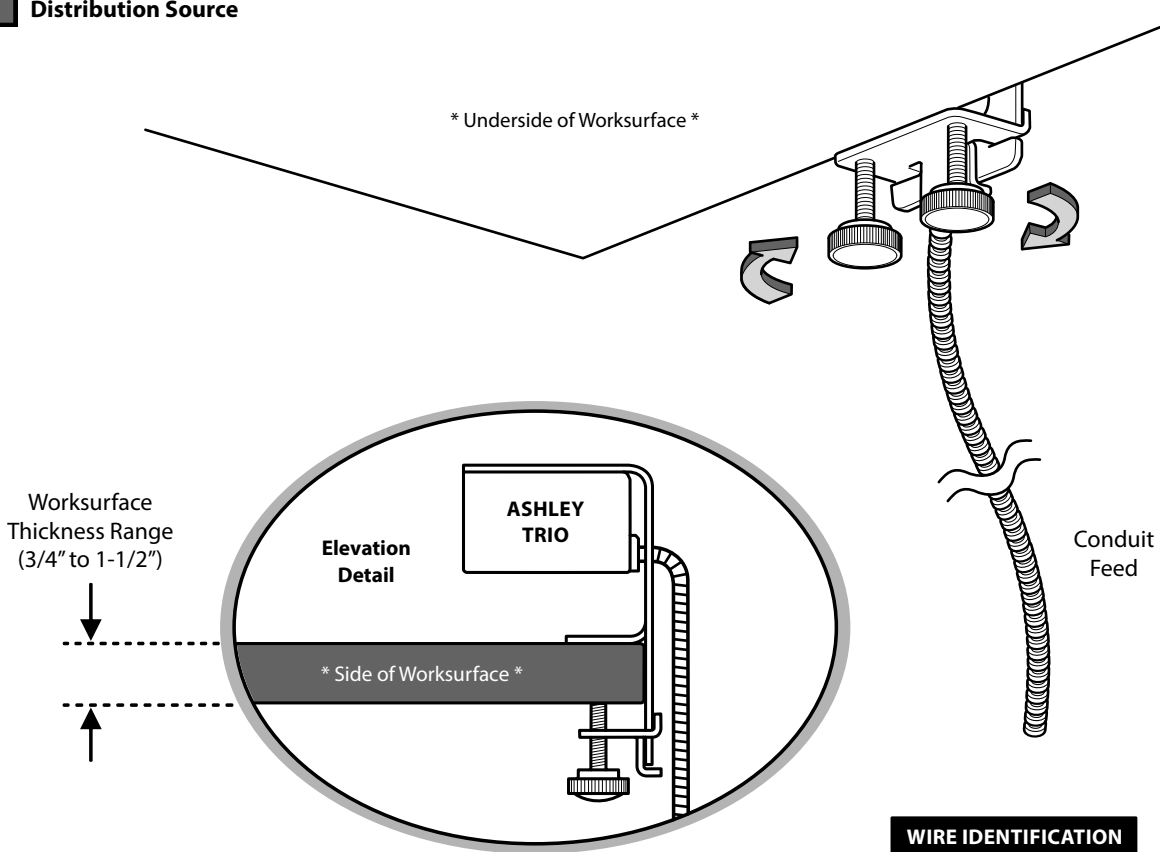



2505 Dekko Drive
Garrett, IN 46738

Service à la clientèle : 800.357.5622

Opération avec Pent® ASHLEY TRIO⁺ - Conduit d'alimentation - Au-dessus de la surface de travail Instruction d'installation

Cet appareil est conforme à la partie 15A des règles de la FCC. Le fonctionnement doit suivre les deux conditions suivantes : (1) Cet appareil ne doit pas provoquer d'interférences nuisibles, et (2) cet appareil doit accepter toute interférence reçue, y compris des interférences qui pourraient provoquer un fonctionnement indésirable.

Outils requis

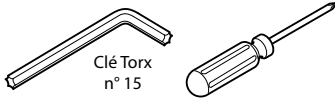

Clé Torx
n° 15

*REMARQUE SPÉCIALE *

Les options de ports de données optionnels devront être achetées auprès de L-COM. Les numéros de pièces de L-COM ont été fournis à l'étape n° 2.

1 Retirer le couvercle du port de données

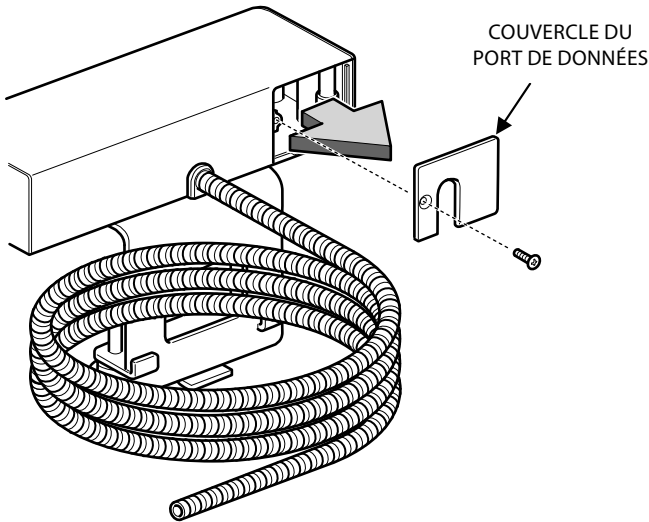

2 Installer l'option de port de données (VGA, RJ45, HDMI, VIDE)

REMARQUE

Voir la fiche n° 2 pour des instructions détaillées

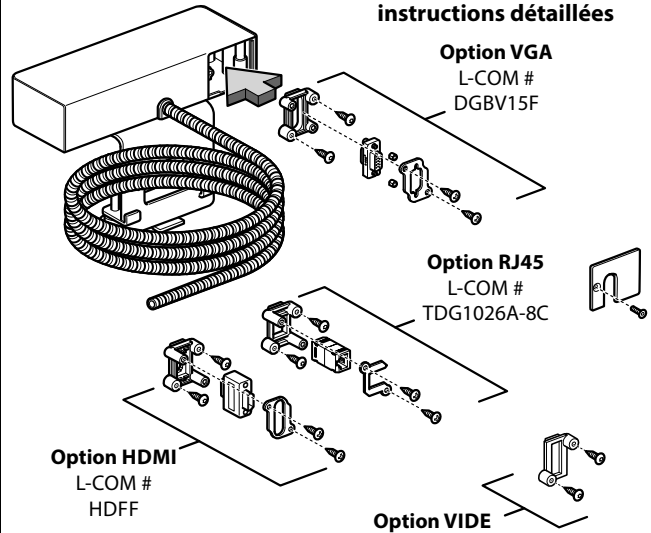

3 Glisser le support derrière la surface de travail

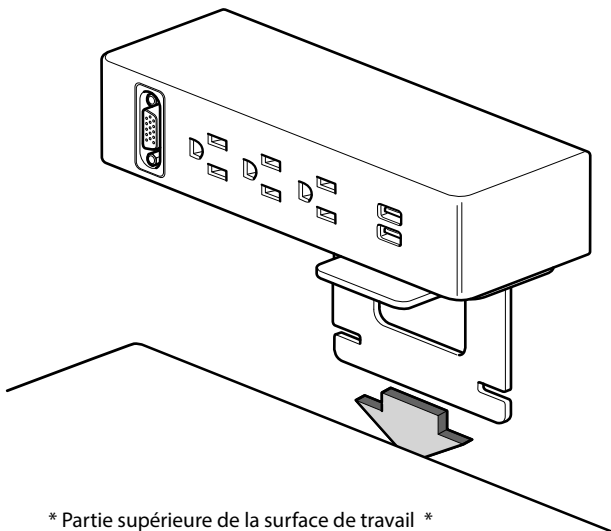

* Partie supérieure de la surface de travail *

4 Installer le support inférieur sous la surface de travail

* Face inférieure de la surface de travail *

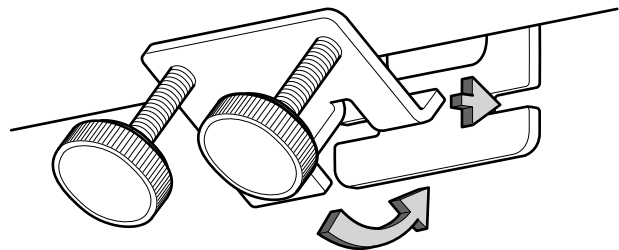



2505 Dekko Drive
Garrett, IN 46738

Service à la clientèle : 800.357.5622

Opération avec Pent® ASHLEY TRIO⁺ - Conduit d'alimentation - Au-dessus de la surface de travail Instruction d'installation

Cet appareil est conforme à la partie 15A des règles de la FCC. Le fonctionnement doit suivre les deux conditions suivantes : (1) Cet appareil ne doit pas provoquer d'interférences nuisibles, et (2) cet appareil doit accepter toute interférence reçue, y compris des interférences qui pourraient provoquer un fonctionnement indésirable.

Outils requis

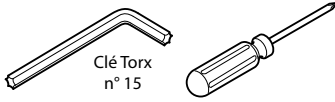

2.1 Installer l'option VGA - (L-COM # DGBV15F)

A Retirer les écrous du connecteur VGA

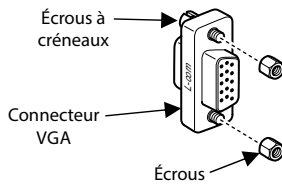

B Installer le support sur le connecteur

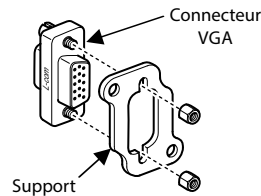

C Installer les composants dans le corps de l'unité

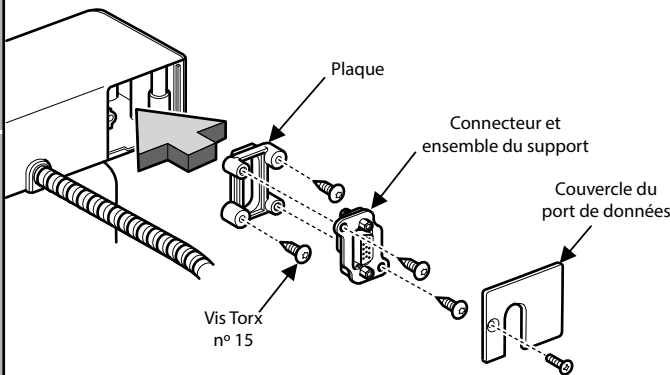

2.2 Installer l'option RJ45 - (L-COM # TDG1026A-8C)

A Associer les surfaces inclinées de la plaque et du connecteur

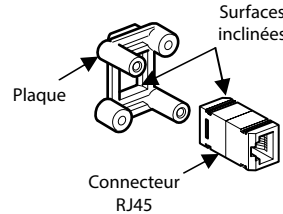

B Installer le support

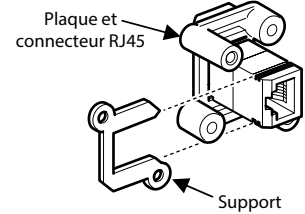

C Installer les composants dans le corps de l'unité

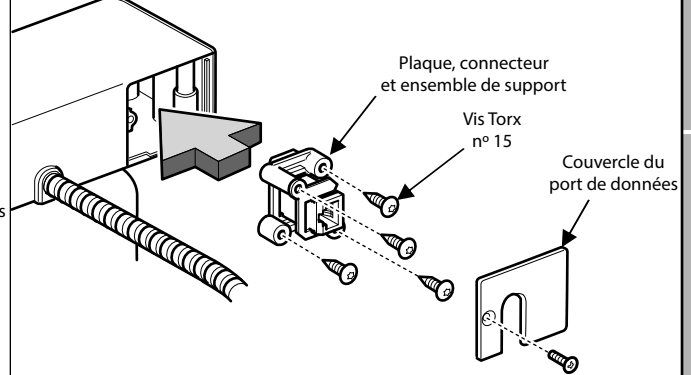

2.3 Installer l'option HDMI - (L-COM # HDFF)

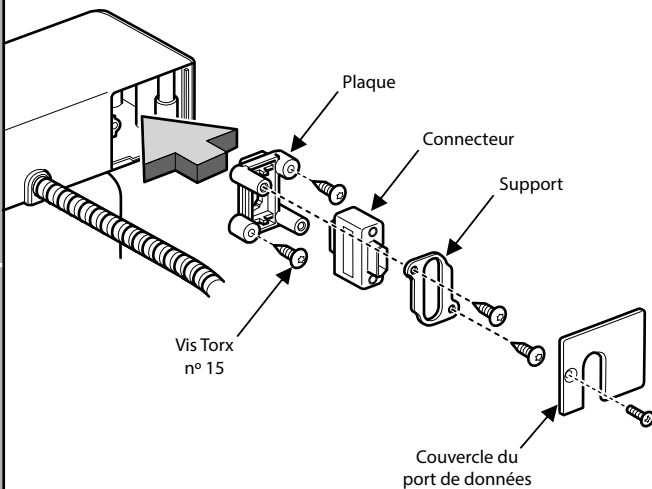

2.4 Installer l'option VIDE

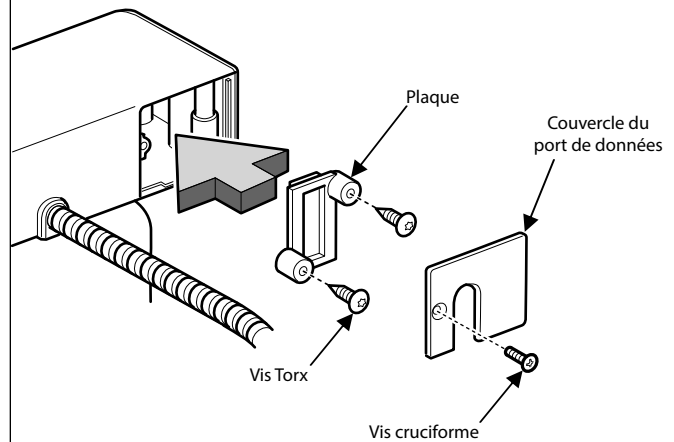



2505 Dekko Drive
Garrett, IN 46738

Service à la clientèle : 800.357.5622

Opération avec Pent®

ASHLEY TRIO⁺

- Conduit d'alimentation -
Au-dessus de la surface de travail

Instruction d'installation

Cet appareil est conforme à la partie 15A des règles de la FCC. Le fonctionnement doit suivre les deux conditions suivantes : (1) Cet appareil ne doit pas provoquer d'interférences nuisibles, et (2) cet appareil doit accepter toute interférence reçue, y compris des interférences qui pourraient provoquer un fonctionnement indésirable.

Outils requis

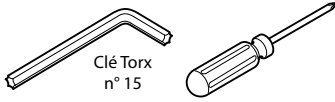

5

Acheminer le conduit d'alimentation vers la source de distribution électrique la plus proche

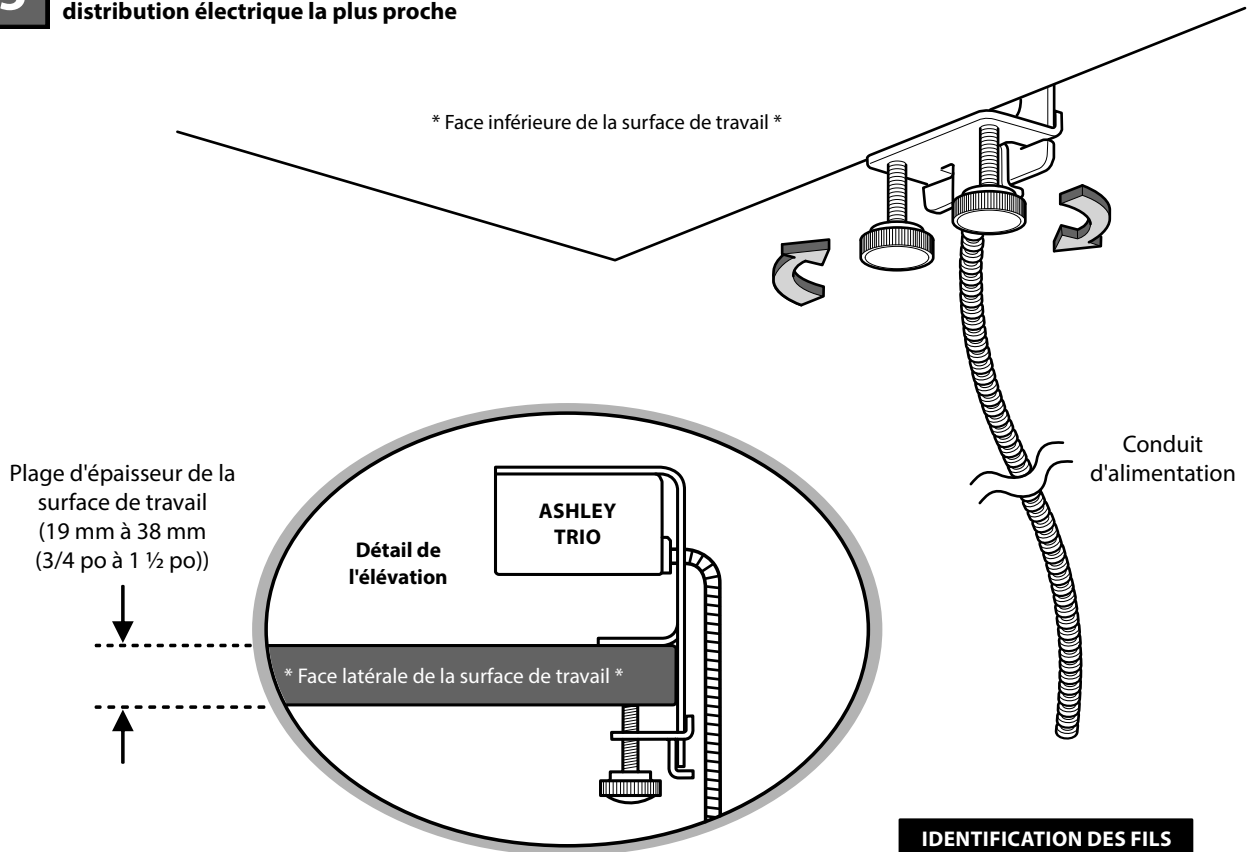

IDENTIFICATION DES FILS

- LIGNE (NOIR)
- MASSE (VERT)
- NEUTRE (BLANC)