



STO-WAY
LOCKER POWER EDITION



STO-WAY PROVIDES:

Personalized Power Source

Secure and personal charging power accessed in arm's reach within locker cavity; exclusive to the locker occupant. 5 Amps of USB & USB-C power charge mobile devices to keep batteries fully charged when on-the-go.

One-Of-A-Kind Experience

Create an innovative user experience with Sto-Way's integrated 120 Volts of power for public facilities like hospitals, schools, athletic and recreational areas.

Versatile Orientation

Adaptable to new or existing lockers and flexible in-nature, mount Sto-Way vertically or horizontally; anywhere inside the locker interior. Power placement is in your control.

DaisyLink™ Capability

Multiple units connect, locker-to-locker, from one infeed. Unsightly cords remain concealed from locker occupant(s).

Modern Aesthetic & Color

Sto-Way's recessed style provides a sleek and sophisticated impression despite locker construction; wood or metal. Its blended composition integrates seamlessly with the locker interior. The surface-mount style adds fun to any existing locker interior. Choose from muted neutrals to bold brights to accentuate the locker design and its visibility within the interior.

Pre-Specified Cable Lengths:

Sto-Way recessed units are standardly equipped with a 7" metal conduit, while the surface units have a 24". Each conduit has been measured for optimal spacing between lockers for continuous daisy-chain connectivity. Corded models also available.

ETL Listed for US and Canada

THE NEW CHARGING STANDARD

INNOVATIVE LOCKER POWER SOLUTIONS

Deliver next-level innovation by providing 120 Volts of personal power, and 5 Amps of USB and USB-C charging, exclusively to the locker occupant. Personal mobile devices are protected and concealed; occupants return to a boost of battery, keeping them powered up for a productive day ahead. Adaptable to new or existing lockers, Sto-Way functions either as a surface-mount style or as a seamless recessed-mount aesthetic to the locker interior. Both styles are compatible with ECA's DaisyLink™ System. Reshape the norm of conventional locker usage. With our innovative locker power solutions, you can deliver the fundamental charging needs of today's tech-progressive world.

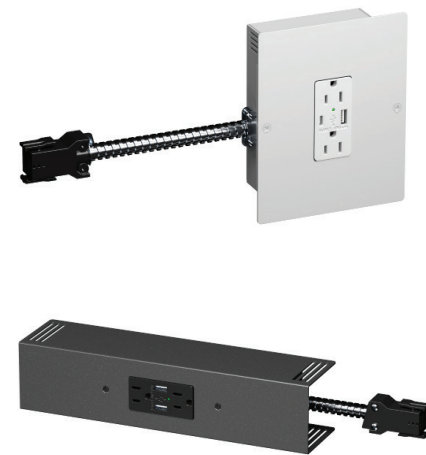

STO-WAY

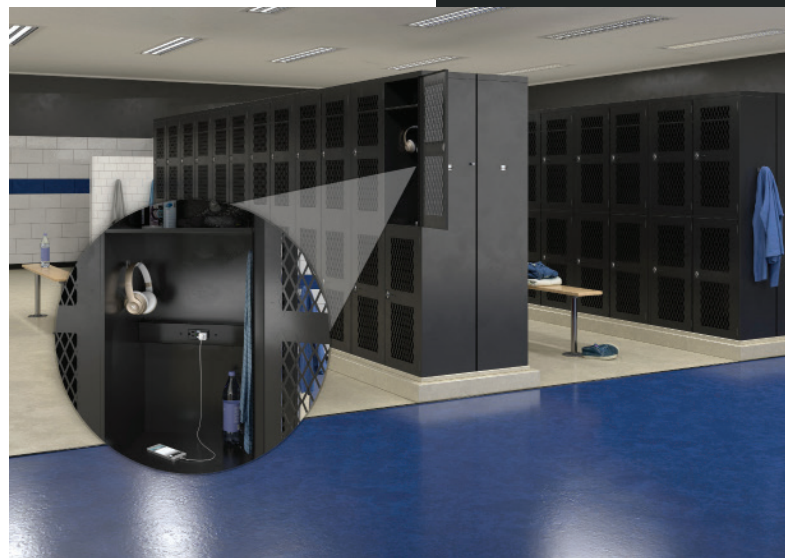





FEATURES:

Applications

- Bezel / In-Surface (Recessed)
- Surface-Mount (Surface)
- Lockers

Standard Finishes

- Silver Pearl 
- Gloss White 
- Black 
- Graphite Gray 

Specifications

- 2 - 15A/120V AC Tamper Resistant Receptacles
- GFCI* Outlets with RESET/TEST Buttons Available
- 5A/25W, 5VDC USB and USB-C Charging Ports (Available on Select Models)
- Offered as 2 Mounting-Styles: Recessed-Style for Metal & Wood Surfaces (Flush to Locker Interior); Surface-Style (On-surface of Locker Interior)
- Corded & DaisyLink Options
- Standard Cord Length: 108"
- Compatible with 4 Wire 2 Circuit DaisyLink™ System: Standard 24" Flex Metal Conduit for Recessed Version; Standard 7" Flex Metal Conduit for Surface Version
- ETL Listed for US and Canada

*NOTE: GFCI (Ground-Fault Circuit Interrupter) is a fast-acting circuit breaker designed to shut o electric power in the event of a ground-fault; protecting any persons from receiving shock in the event of being exposed to water. Each outlet has a RESET and TEST button. OSHA Standard.

Dimensions

- Sto-Way Recessed Standard Dimensions (Unit Dimensions Identical for Wood & Metal Configurations): 6.25" x 2.35" x 5.19"
- Sto-Way Surface Standard Dimensions: 11.75" x 2.95" x 2.65"

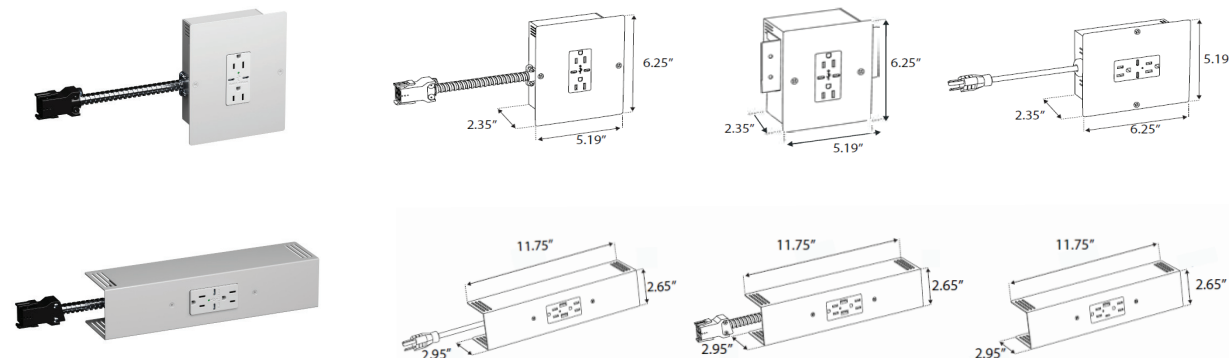

DESCRIPTION

FINISH

PART NUMBER

SURFACE - DaisyLink™

• Circuit 1: 2 Power w/ 7" Flex Metal Conduit	Black Silver Pearl Gloss White Graphite Gray	STS-2-41-B-7 STS-2-41-S-7 STS-2-41-GW-7 STS-2-41-GG-7
• Circuit 1: 2 Power GFCI* w/ 7" Flex Metal Conduit	Black Silver Pearl Gloss White Graphite Gray	STS-2GF-41-B-7 STS-2GF-41-S-7 STS-2GF-41-GW-7 STS-2GF-41-GG-7
• Circuit 1: 2 Power 2 USB w/ 7" Flex Metal Conduit	Black Silver Pearl Gloss White Graphite Gray	STS-2U-41-B-7 STS-2U-41-S-7 STS-2U-41-GW-7 STS-2U-41-GG-7
• Circuit 1: 2 Power 2 USB-C w/ 7" Flex Metal Conduit	Black Silver Pearl Gloss White Graphite Gray	STS-2U2C-41-B-7 STS-2U2C-41-S-7 STS-2U2C-41-GW-7 STS-2U2C-41-GG-7
• Circuit 1: 2 Power 1 USB & 1 USB-C w/ 7" Flex Metal Conduit	Black Silver Pearl Gloss White Graphite Gray	STS-2UAC-41-B-7 STS-2UAC-41-S-7 STS-2UAC-41-GW-7 STS-2UAC-41-GG-7

SURFACE- DaisyLink™ - No Whip

• Circuit 1: 2 Power	Black Silver Pearl Gloss White Graphite Gray	STS-2-41-B STS-2-41-S STS-2-41-GW STS-2-41-GG
• Circuit 1: 2 Power GFCI*	Black Silver Pearl Gloss White Graphite Gray	STS-2GF-41-B STS-2GF-41-S STS-2GF-41-GW STS-2GF-41-GG
• Circuit 1: 2 Power 2 USB	Black Silver Pearl Gloss White Graphite Gray	STS-2U-41-B STS-2U-41-S STS-2U-41-GW STS-2U-41-GG
• Circuit 1: 2 Power 2 USB-C	Black Silver Pearl Gloss White Graphite Gray	STS-2U2C-41-B STS-2U2C-41-S STS-2U2C-41-GW STS-2U2C-41-GG
• Circuit 1: 2 Power 1 USB 1 USB-C	Black Silver Pearl Gloss White Graphite Gray	STS-2UAC-41-B STS-2UAC-41-S STS-2UAC-41-GW STS-2UAC-41-GG

NOTE: For Circuit 2 options, replace "41" with "42" in Part Number. See Below for DaisyLink Starter & Interconnecting Cable Options.

DESCRIPTION	FINISH	PART NUMBER
-------------	--------	-------------

SURFACE - Corded

• 2 Power w/ 108" Cord	Black Silver Pearl Gloss White Graphite Gray	STS-2-B-108 STS-2-S-108 STS-2-GW-108 STS-2-GG-108
• 2 Power GFCI* w/ 108" Cord	Black Silver Pearl Gloss White Graphite Gray	STS-2GF-B-108 STS-2GF-S-108 STS-2GF-GW-108 STS-2GF-GG-108
• 2 Power 2 USB w/ 108" Cord	Black Silver Pearl Gloss White Graphite Gray	STS-2U-B-108 STS-2U-S-108 STS-2U-GW-108 STS-2U-GG-108
• 2 Power 2 USB-C w/ 108" Cord	Black Silver Pearl Gloss White Graphite Gray	STS-2U2C-B-108 STS-2U2C-S-108 STS-2U2C-GW-108 STS-2U2C-GG-108
• 2 Power 1 USB 1 USB-C w/ 108" Cord	Black Silver Pearl Gloss White Graphite Gray	STS-2UAC-B-108 STS-2UAC-S-108 STS-2UAC-GW-108 STS-2UAC-GG-108

RECESSED - DaisyLink™ (for Metal Lockers)

• Circuit 1: 2 Power w/ 24" Flex Metal Conduit	Black Silver Pearl Gloss White Graphite Gray	STR-2-41-B-24 STR-2-41-S-24 STR-2-41-GW-24 STR-2-41-GG-24
• Circuit 1: 2 Power GFCI* w/ 24" Flex Metal Conduit	Black Silver Pearl Gloss White Graphite Gray	STR-2GF-41-B-24 STR-2GF-41-S-24 STR-2GF-41-GW24 STR-2GF-41GG24
• Circuit 1: 2 Power 2 USB w/ 24" Flex Metal Conduit	Black Silver Pearl Gloss White Graphite Gray	STR-2U-41-B-24 STR-2U-41-S-24 STR-2U-41-GW-24 STR-2U-41-GG-24
• Circuit 1: 2 Power 2 USB-C w/ 24" Flex Metal Conduit	Black Silver Pearl Gloss White Graphite Gray	STR-2U2C-41-B24 STR-2U2C-41-S24 STR-2U2C-41GW24 STR-2U2C-41GG24
• Circuit 1: 2 Power 1 USB 1 USB-C w/ 24" Flex Metal Conduit	Black Silver Pearl Gloss White Graphite Gray	STR-2UAC-41-B24 STR-2UAC-41-S24 STR-2UAC-41GW24 STR-2UAC-41GG24

NOTE: For Circuit 2 options, replace "41" with "42" in Part Number. See Below for DaisyLink Starter & Interconnecting Cable Options.

DESCRIPTION	FINISH	PART NUMBER
-------------	--------	-------------

RECESSED - DaisyLink™ - No Whip (for Metal Lockers)

• Circuit 1: 2 Power	Black Silver Pearl Gloss White Graphite Gray	STR-2-41-B STR-2-41-S STR-2-41-GW STR-2-41-GG
• Circuit 1: 2 Power GFCI*	Black Silver Pearl Gloss White Graphite Gray	STR-2GF-41-B STR-2GF-41-S STR-2GF-41-GW STR-2GF-41-GG
• Circuit 1: 2 Power 2 USB	Black Silver Pearl Gloss White Graphite Gray	STR-2U-41-B STR-2U-41-S STR-2U-41-GW STR-2U-41-GG
• Circuit 1: 2 Power 2 USB-C	Black Silver Pearl Gloss White Graphite Gray	STR-2U2C-41-B STR-2U2C-41-S STR-2U2C-41-GW STR-2U2C-41GG
• Circuit 1: 2 Power 1 USB 1 USB-C	Black Silver Pearl Gloss White Graphite Gray	STR-2UAC-41-B STR-2UAC-41-S STR-2UAC-41-GW STR-2UAC-41-GG

RECESSED - Corded (for Metal Lockers)

• 2 Power w/ 108" Cord	Black Silver Pearl Gloss White Graphite Gray	STR-2-B-108 STR-2-S-108 STR-2-GW-108 STR-2-GG-108
• 2 Power GFCI* w/ 108" Cord	Black Silver Pearl Gloss White Graphite Gray	STR-2GF-B-108 STR-2GF-S-108 STR-2GF-GW-108 STR-2GF-GG-108
• 2 Power 2 USB w/ 108" Cord	Black Silver Pearl Gloss White Graphite Gray	STR-2U-B-108 STR-2U-S-108 STR-2U-GW-108 STR-2U-GG-108
• 2 Power 2 USB-C w/ 108" Cord	Black Silver Pearl Gloss White Graphite Gray	STR-2U2C-B-108 STR-2U2C-S-108 STR-2U2C-GW-108 STR-2U2C-GG-108
• 2 Power 1 USB 1 USB-C w/ 108" Cord	Black Silver Pearl Gloss White Graphite Gray	STR-2UAC-B-108 STR-2UAC-S-108 STR-2UAC-GW-108 STR-2UAC-GG-108

NOTE: For Circuit 2 options, replace "41" with "42" in Part Number. See Below for DaisyLink Starter & Interconnecting Cable Options.

DESCRIPTION	FINISH	PART NUMBER
RECESSED - DaisyLink™ (for Wood Lockers)		
• Circuit 1: 2 Power w/ 24" Flex Metal Conduit	Black Silver Pearl Gloss White Graphite Gray	STR-W-2-41-B24 STR-W-2-41-S24 STR-W-2-41GW24 STR-W-2-41GG24
• Circuit 1: 2 Power GFCI* w/ 24" Flex Metal Conduit	Black Silver Pearl Gloss White Graphite Gray	STR-W-2GF-41B24 STR-W-2GF-41S24 STR-W-2GF41GW24 STR-W-2GF41GG24
• Circuit 1: 2 Power 2 USB w/ 24" Flex Metal Conduit	Black Silver Pearl Gloss White Graphite Gray	STR-W-2U-41-B24 STR-W-2U-41-S24 STR-W-2U-41GW24 STR-W-2U-41GG24
• Circuit 1: 2 Power 2 USB-C w/ 24" Flex Metal Conduit	Black Silver Pearl Gloss White Graphite Gray	STR-W-2U2C41B24 STR-W-2U2C41S24 STR-W2U2C41GW24 STR-W2U2C41GG24
• Circuit 1: 2 Power 1 USB 1 USB-C w/ 24" Flex Metal Conduit	Black Silver Pearl Gloss White Graphite Gray	STR-W-2UAC41B24 STR-W-2UAC41S24 STR-W2UAC41GW24 STR-W2UAC41GG24

RECESSED - DaisyLink™ - No Whip (for Wood Lockers)

• Circuit 1: 2 Power	Black Silver Pearl Gloss White Graphite Gray	STR-W-2-41-B STR-W-2-41-S STR-W-2-41-GW STR-W-2-41-GG
• Circuit 1: 2 Power GFCI*	Black Silver Pearl Gloss White Graphite Gray	STR-W-2GF-41-B STR-W-2GF-41S STR-W-2GF-41-GW STR-W-2GF41-GG
• Circuit 1: 2 Power 2 USB	Black Silver Pearl Gloss White Graphite Gray	STR-W-2U-41-B STR-W-2U-41-S STR-W-2U-41-GW STR-W-2U-41-GG
• Circuit 1: 2 Power 2 USB-C	Black Silver Pearl Gloss White Graphite Gray	STR-W-2U2C-41-B STR-W-2U2C-41-S STR-W-2U2C-41GW STR-W-2U2C-41GG
• Circuit 1: 2 Power 1 USB 1 USB-C	Black Silver Pearl Gloss White Graphite Gray	STR-W-2UAC-41-B STR-W-2UAC-41-S STR-W-2UAC-41GW STR-W-2UAC-41GG

NOTE: For Circuit 2 options, replace "41" with "42" in Part Number. See Below for DaisyLink Starter & Interconnecting Cable Options.

DESCRIPTION	FINISH	PART NUMBER
RECESSED - Corded (for Wood Lockers)		
• 2 Power w/ 108" Cord	Black Silver Pearl Gloss White Graphite Gray	STR-W-2-B-108 STR-W-2-S-108 STR-W-2-GW-108 STR-W-2-GG-108
• 2 Power GFCI* w/ 108" Cord	Black Silver Pearl Gloss White Graphite Gray	STR-W-2GF-B-108 STR-W-2GF-S-108 STR-W-2GF-GW108 STR-W-2GF-GG108
• 2 Power 2 USB w/ 108" Cord	Black Silver Pearl Gloss White Graphite Gray	STR-W-2U-B-108 STR-W-2U-S-108 STR-W-2U-GW-108 STR-W-2U-GG-108
• 2 Power 2 USB-C w/ 108" Cord	Black Silver Pearl Gloss White Graphite Gray	STR-W-2U2C-B108 STR-W-2U2C-S108 STR-W-2U2CGW108 STR-W-2U2CGG108
• 2 Power 1 USB 1 USB-C w/ 108" Cord	Black Silver Pearl Gloss White Graphite Gray	STR-W-2UAC-B108 STR-W-2UAC-S108 STR-W-2UACGW108 STR-W-2UACGG108

Starter & Interconnecting Cable Options

• Female/Female Interconnecting Cable	12" -180" Cable	42-FF-Length*
• Female/Male Interconnecting Cable	12"-180" Cable	42FM-Length*
• Hardwire Starter Cable	12"-180" Cable	42SB2-Length*
• T-Connector used to branch into different directions	Black	Daisy-T
• DaisyLink Nylon Black Cable Covers - Add "B" to cabling part number	Black	Cable Covers "B"

Specify in increments of 1" Cable Lengths in Part Number. Cable Lengths Minimum of 12" - 180" Maximum.