



VILLA™ II SERIES

VILLA™ II SERIES



WHERE FORM MEETS FUNCTION

FLEXIBLE POWER OPTIONS

Don't go another second without your devices. Our Villa™ II Series gives you easy access to power, 2.1A USB charging, and data capabilities, both above and below the work surface. The Series includes below-surface outlets to supply stationary components like lamps, monitors, and computers. To make ordering simple, our DaisyLink™ Quick Kits have all the components needed to power standard table configurations. If your needs go beyond our standard packages, no problem. We'll help you build a custom option.



FEATURES:

Applications

Bezel / In-Surface
Training Tables

Standard Finishes

- Silver Pearl
- Black
- Gloss White

Flush Style Grommet Finishes

- Brushed Aluminum
- Stainless Steel
- Silver Pearl
- Black
- Gloss White

Lift Style Grommet Finishes

- Silver Pearl
- Black
- Gloss White

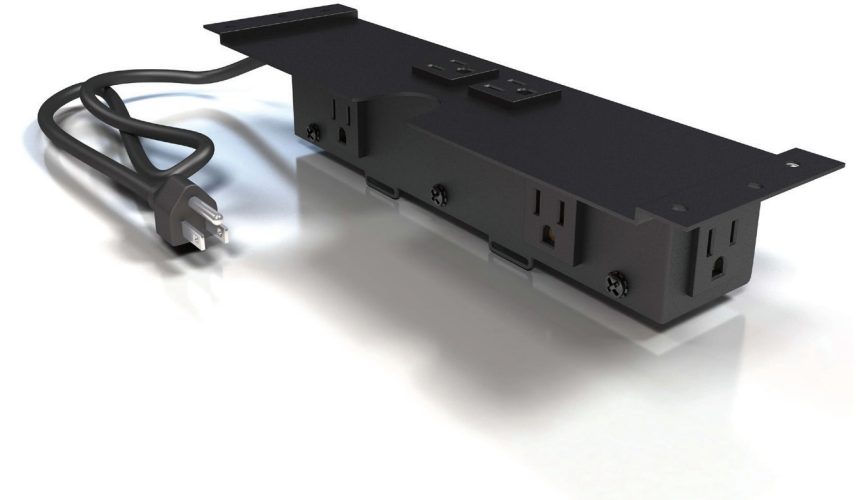

Specifications

- 4 - 15A, 120V AC Power Receptacles
- DaisyLink Units with 120V Controlled Receptacles Available *(Comply with Ashrae 90.1 & Title 24 Energy Efficiency Regulations)*
- 2 - 2.1A/10.5W USB Charging Ports *(Available on Select Models)*
- 1 Convenience Outlet *(Available on Corded Models Only)*
- Data Knockouts
- Corded, DaisyLink, DaisyLink Units with Controlled Receptacles, Quick Kit and Hardwire Options
- Standard Cord Length: 36", 72" or 108"
- DaisyLink Configurations Compatible with the 4 Wire 2 Circuit Starter and Interconnecting Cables & Accessories
- 4 Cable Clamps & Mounting Screws Included for Installation
- Optional Lift or Flush Grommet Accessory *(Purchased Separately)*
- Recommended Table Thickness for Villa™ Grommet: 1" Min.
- Recommended Table Cut Out for Villa™ Grommet: 3" x 5.25"
- Power Bases UL/ETL Listed for US and Canada

Dimensions

- Villa™ II Power Base With Data Standard Dimensions: 12" x 3.13" x 2.17"
- Villa II Power Base With USB & Data Standard Dimensions: 12" x 3.13" x 3.08"
- Villa™ Grommet Standard Dimensions: 3.39" x 5.68"

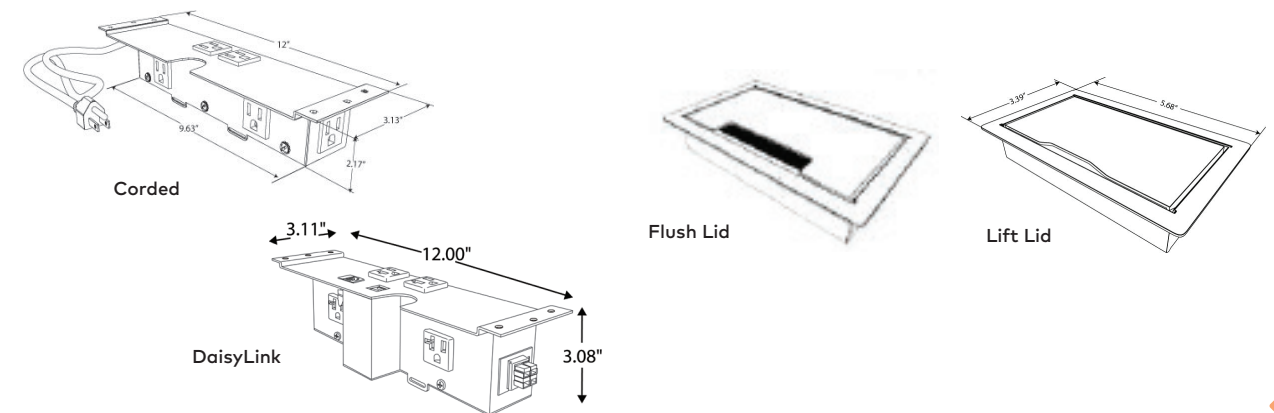

DESCRIPTION**FINISH****PART NUMBER****Villa™ II - Corded - Single Circuit
Data & Convenience Outlets**

• 2 Power Up, 2 Power Below, 1 Convenience Outlet, 2 Data Knockouts	Black	VIL2-C2-DKOB-__
	Silver Pearl	VIL2-C2-DKOS-__
	Gloss White	VIL2-C2-DKOW-__
• 2 Power Up, 2 Power Below, 1 Convenience Outlet, 2 RJ45 Cat 6 Data	Black	VIL2-C2-D-B-__
	Silver Pearl	VIL2-C2-D-S-__
	Gloss White	VIL2-C2-D-W-__

**Villa™ II - Corded - Single Circuit
Data, USB & Convenience Outlets**

• 2 Power Up, 2 Power Below, 1 Convenience Outlet, (2) 2.1A USB charging ports, 1 Data	Black	VIL2-C-U-DKOB-__
	Silver Pearl	VIL2-C-U-DKOS-__
	Gloss White	VIL2-C-U-DKOW-__
• 2 Power Up, 2 Power Below, 1 Convenience Outlet, (2) 2.1A USB charging ports, and 1 RJ45 Cat 6 Data	Black	VIL2-C-U-D-B-__
	Silver Pearl	VIL2-C-U-D-S-__
	Gloss White	VIL2-C-U-D-W-__

Replace __ in the Part Number with Appropriate Cord Length of your choice: 36", 72", or 108". Pricing is standard for these specified lengths.

NOTE: Cord lengths 144" and 180" require an additional up-charge fee. Unit comes equipped with 4 cable clamps and mounting screws.

Villa™ II Grommets

• Lift Lid	Black	VIL-GROM-L-S
	Silver Pearl	VIL-GROM-L-B
	Gloss White	VIL-GROM-L-GW
• Flush Lid	Brushed Aluminum	VIL-GROM-F-AL
	Brushed Stainless Steel	VIL-GROM-F-SS
	Silver Pearl	VIL-GROM-F-S
	Black	VIL-GROM-F-B
	Gloss White	VIL-GROM-F-W

Villa™ II Data Options

• RJ45 Siemon Cat 6, female/punch down, Black	Black	RJ45-B
• HDMI keystone female/female, Black	Black	HDMI-KEY-B
• USB 2.0 Type A/A Keystone female/female, Black	Black	USB-KEY-20AA-B
• USB 2.0 Type A/A Keystone female/female, White	White	USB-KEY-20AA-W

DESCRIPTION	FINISH/ LENGTH	PART NUMBER
Villa™ II - DaisyLink™ Data Only		
• 4 Power, 2 on Top and 2 Below, and 2 Data Knockouts	Black Silver Pearl Gloss White	VIL2-4-1-DKO-B VIL2-4-1-DKO-S VIL2-4-1-DKO-W
• 4 Power, 2 on Top and 2 Below, and 2 RJ45 Cat 6 Data	Black Silver Pearl Gloss White	VIL2-4-1-D-B VIL2-4-1-D-S VIL2-4-1-D-W
Villa™ II - DaisyLink™ Data & USB		
• 4 Power, 2 power on top with 2 USB 2.1 AMP charging ports, Knockout for RJ45 Cat 6 Data, and 2 power below	Black Silver Pearl Gloss White	VIL2-41-U-DKO-B VIL2-41-U-DKO-S VIL2-41-U-DKO-W
• 4 Power, 2 power on top with 2 USB 2.1 AMP charging ports, RJ45 Cat 6 Data, and 2 power below	Black Silver Pearl Gloss White	VIL2-4-1-U-D-B VIL2-4-1-U-D-S VIL2-4-1-U-D-W

Change "1" to a "2" to specify Circuit
See Starter and Interconnecting Cable Options Below

Villa™ II - DaisyLink™ - Controlled Receptacles

• Energy Efficient Villa II with DaisyLink, (2) cir 1 Controlled Receptacles on top, (2) cir 2 non-controlled receptacles on bottom, (2) 2.1A USB charging ports, and (1) RJ45 cat6 data	Black Silver Pearl Gloss White	VIL2-4-TCC-UDB VIL2-4-TCC-UDS VIL2-4-TCC-UDGW
• Energy Efficient Villa II with DaisyLink, (2) cir 1 Controlled Receptacles on top, (2) cir 2 noncontrolled receptacles on bottom, (2) 2.1A USB charging ports, and (1) data knockout	Black Silver Pearl Gloss White	VIL2-4-TCCUDKOB VIL2-4-TCCUDKOS VIL2-4TCCUDKOGW

See Starter and Interconnecting Cable Options Below

Villa™ II Data Options

• RJ45 Siemon Cat 6, female/punch down, Black	Black	RJ45-B
• HDMI keystone female/female, Black	Black	HDMI-KEY-B
• USB 2.0 Type A/A Keystone female/female, Black	Black	USB-KEY-20AA-B
• USB 2.0 Type A/A Keystone female/female, White	White	USB-KEY-20AA-W

DaisyLink™ Starter and Interconnecting Cable Options

• Female/Female Interconnecting Cable	12" -180" Cable	42-FF-Length*
• Female/Male Interconnecting Cable	12" -180" Cable	42FM-Length*
• Hardwire Starter Cable	12" -180" Cable	42SB2-Length*
• T-Connector used to branch into different directions	Black	Daisy-T
• DaisyLink Nylon Black Cable Covers - Add "B" to cabling part number	Black	Cable Covers "B"

Specify in increments of 1" Cable Lengths in Part Number.
Cable Lengths Minimum of 12" - 180" Maximum.

DESCRIPTION	FINISH/ LENGTH	PART NUMBER
Villa™ II Grommets		
• Lift Lid	Black Silver Pearl Gloss White	VIL-GROM-L-S VIL-GROM-L-B VIL-GROM-L-GW
• Flush Lid	Brushed Aluminum Brushed Stainless Steel Silver Pearl Black Gloss White	VIL-GROM-F-AL VIL-GROM-F-SS VIL-GROM-F-S VIL-GROM-F-B VIL-GROM-F-W

QUICK KIT TABLE CHART

36" Table Kit

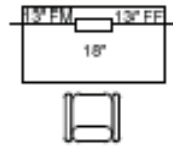

- Kit Includes:**
 1 Villa Grommet
 1 Villa Power Base
 1 13" FM Cable
 1 13" FF Cable
 4 Cable Clamps

42" Table Kit

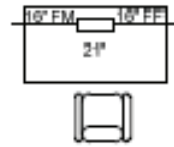

- Kit Includes:**
 1 Villa Grommet
 1 Villa Power Base
 1 16" FM Cable
 1 16" FF Cable
 4 Cable Clamps

48" Table Kit

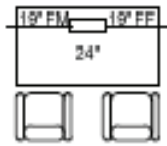

- Kit Includes:**
 1 Villa Grommet
 1 Villa Power Base
 1 19" FM Cable
 1 19" FF Cable
 4 Cable Clamps

60" Table Kit-Single

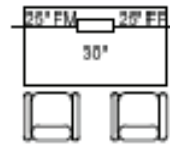

- Single Kit Includes:**
 1 Villa Grommet
 1 Villa Power Base
 1 25" FM Cable
 1 25" FF Cable
 4 Cable Clamps

60" Table Kit-Double

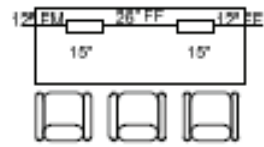

- Double Kit Includes:**
 2 Villa Grommets
 2 Villa Power Bases
 1 12" FM Cable
 1 12" FF Cable
 1 17" FF Cable
 6 Cable Clamps

72" Table Kit-Single

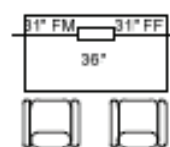

- Single Kit Includes:**
 1 Villa Grommet
 1 Villa Power Base
 1 31" FM Cable
 1 31" FF Cable
 4 Cable Clamps

72" Table Kit-Double

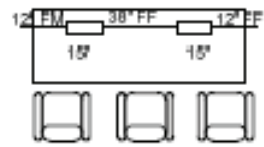

- Double Kit Includes:**
 2 Villa Grommets
 2 Villa Power Bases
 1 12" FM Cable
 1 12" FF Cable
 1 26" FF Cable
 6 Cable Clamps

84" Table Kit-Double

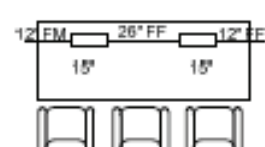

- Double Kit Includes:**
 2 Villa Grommets
 2 Villa Power Bases
 1 12" FM Cable
 1 12" FF Cable
 1 41" FF Cable
 6 Cable Clamps

96" Table Kit-Double

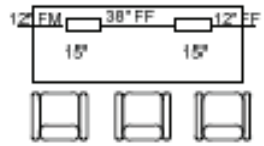

- Double Kit Includes:**
 2 Villa Grommets
 2 Villa Power Bases
 1 12" FM Cable
 1 12" FF Cable
 1 51" FF Cable
 6 Cable Clamps

Quick Kit configurations assume there is a 1/2" of cabling on each side of the table to make the table to table connection. Optional DaisyLink cable covers are also available. Each Villa unit comes with 10 mounting screws.

DESCRIPTION

FINISH

PART NUMBER

SINGLE Power & Data Ready

Lift Lid Options:

- 4 Power and 2 Data Knockouts
- 4 Power and 2 RJ45 Cat 6 Data

- Black
- Silver Pearl
- Gloss White
- Black
- Silver Pearl
- Gloss White

- VIL2-41-DKOB_K
- VIL2-41-DKOS_K
- VIL2-41-DKOW_K
- VIL2-41-D-B-_K
- VIL2-41-D-S-_K
- VIL2-41-D-W-_K

Flush Lid Options:

- 4 Power and 2 Data Knockouts
- 4 Power and 2 RJ45 Cat 6 Data

- Black
- Silver Pearl
- Gloss White
- Brushed Aluminum
- Brushed Stainless Steel
- Black
- Silver Pearl
- Gloss White
- Brushed Aluminum
- Brushed Stainless Steel

- VIF2-41-DKOB_K
- VIF2-41-DKOS_K
- VIF2-41-DKOW_K
- VIF2-41-DKOAL_K
- VIF2-41-DKOSS_K
- VIF2-41-D-B-_K
- VIF2-41-D-S-_K
- VIF2-41-D-W-_K
- VIF2-41-D-AL-_K
- VIF2-41-D-SS-_K

Replace ____ in Single Kit Part Number (K) with 36", 42", 48", 60", 66", 72", 84" or 96" for table length being specified. Pricing is standard for all table lengths.

SINGLE Power, USB & Data Ready

Lift Lid Options:

- 4 Power, 2 USB 2.1 AMP charging ports, and 1 data knockout
- 4 Power, 2 USB 2.1 AMP charging ports, and 1 RJ45 Cat 6 Data

- Black
- Silver Pearl
- Gloss White
- Black
- Silver Pearl
- Gloss White

- VIL2U-41DKOB_K
- VIL2U-41DKOS_K
- VIL2U-41DKOGW_K
- VIL2U-41-D-B_K
- VIL2U-41-D-S_K
- VIL2U-41-D-GW_K

Flush Lid Options:

- 4 Power, 2 USB 2.1 AMP charging ports, and 1 data knockout
- 4 Power, 2 USB 2.1 AMP charging ports, and 1 RJ45 Cat 6 Data

- Black
- Silver Pearl
- Gloss White
- Brushed Aluminum
- Brushed Stainless Steel
- Black
- Silver Pearl
- Gloss White
- Brushed Aluminum
- Brushed Stainless Steel

- VIF2U-41DKOB_K
- VIF2U-41DKOS_K
- VIF2U-41DKOGW_K
- VIF2U-41DKOAL_K
- VIF2U-41DKOSS_K
- VIF2U-41-D-B_K
- VIF2U-41-D-S_K
- VIF2U-41-D-GW_K
- VIF2U-41-D-AL_K
- VIF2U-41-D-SS_K

Replace ____ in Single Kit Part Number (K) with 36", 42", 48", 60", 66", 72", 84" or 96" for table length being specified. Pricing is standard for all table lengths.

DESCRIPTION**FINISH****PART NUMBER****DOUBLE**

Power & Data Ready

Lift Lid Options:

• 4 Power and 2 Data Knockouts	Black	VIL2-41-DKOB__DK
	Silver Pearl	VIL2-41-DKOS__DK
	Gloss White	VIL2-41-DKOW__DK
• 4 Power and 2 RJ45 Cat 6 Data	Black	VIL2-41-D-B-__DK
	Silver Pearl	VIL2-41-D-S-__DK
	Gloss White	VIL2-41-D-W-__DK

Flush Lid Options:

• 4 Power and 2 Data Knockouts	Black	VIF2-41-DKOB__DK
	Silver Pearl	VIF2-41-DKOS__DK
	Gloss White	VIF2-41-DKOW__DK
	Brushed Aluminum	VIF2-41-DKOAL__DK
	Brushed Stainless Steel	VIF2-41-DKOSS__DK
• 4 Power and 2 RJ45 Cat 6 Data	Black	VIF2-41-D-B-__DK
	Silver Pearl	VIF2-41-D-S-__DK
	Gloss White	VIF2-41-D-W-__DK
	Brushed Aluminum	VIF2-41-D-AL-__DK
	Brushed Stainless Steel	VIF2-41-D-SS-__DK

Replace ____ in Single Kit Part Number (K) with 36", 42", 48", 60", 66", 72", 84" or 96" for table length being specified.
Pricing is standard for all table lengths.

DOUBLE

Power, USB & Data Ready

Lift Lid Options:

• 4 Power, 2 USB 2.1 AMP charging ports, and 1 data knockout	Black	VIL2U-41DKOB__DK
	Silver Pearl	VIL2U-41DKOS__DK
	Gloss White	VIL2U-41DKOGW__DK
• 4 Power, 2 USB 2.1 AMP charging ports, and 1 RJ45 Cat 6 Data	Black	VIL2U-41-D-B__DK
	Silver Pearl	VIL2U-41-D-S__DK
	Gloss White	VIL2U-41-D-GW__DK

Flush Lid Options:

• 4 Power, 2 USB 2.1 AMP charging ports, and 1 data knockout	Black	VIF2U-41DKOB__DK
	Silver Pearl	VIF2U-41DKOS__DK
	Gloss White	VIF2U-41DKOGW__DK
	Brushed Aluminum	VIF2U-41DKOAL__DK
	Brushed Stainless Steel	VIF2U-41DKOSS__DK
• 4 Power, 2 USB 2.1 AMP charging ports, and 1 RJ45 Cat 6 Data	Black	VIF2U-41-D-B__DK
	Silver Pearl	VIF2U-41-D-S__DK
	Gloss White	VIF2U-41-D-GW__DK
	Brushed Aluminum	VIF2U-41-D-AL__DK
	Brushed Stainless Steel	VIF2U-41-D-SS__DK

Replace ____ in Single Kit Part Number (K) with 36", 42", 48", 60", 66", 72", 84" or 96" for table length being specified.
Pricing is standard for all table lengths.

