

STU
DIO

BY DEKKO

2505 Dekko Drive
Garrett, IN 46738
Customer Service: 800.357.5622

ASHLEY TRIO

- Corded -

Above Worksurface Mounting Installation Instruction

This device complies with part 15A of the FCC Rules. Operation is subject to the following two conditions: (1) This device may not cause harmful interference, and (2) this device must accept any interference received, including interference that may cause undesired operation.

Tools Required



NOTE

All Tech Adapters Need to be Mounted in the
↑ "UP" ↑ Position. (Refer to the back of Parts)

1 Remove Data Port Cover and Blank Adapter

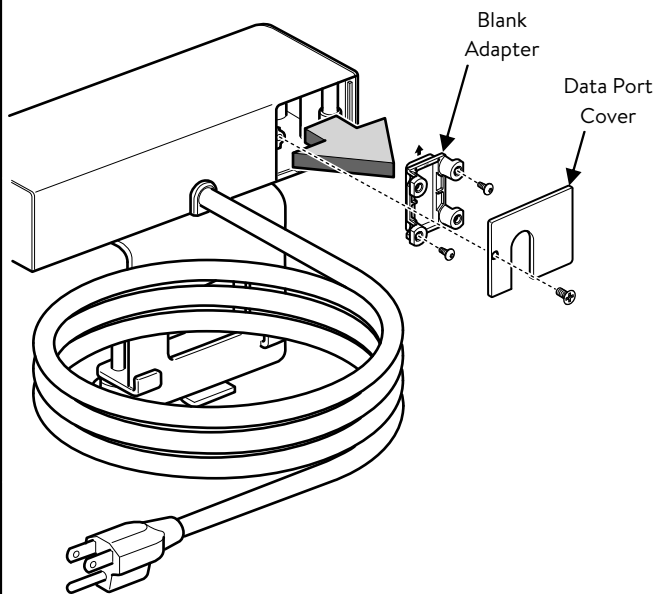

2 Install Data Port Option (VGA, RJ45, HDMI, BLANK)

NOTE

See Sheet #2 for Detailed Instructions

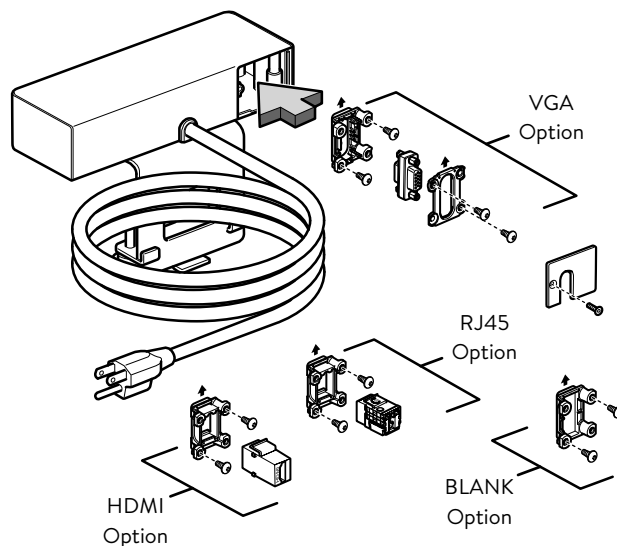

3 Slide Bracket Behind Worksurface

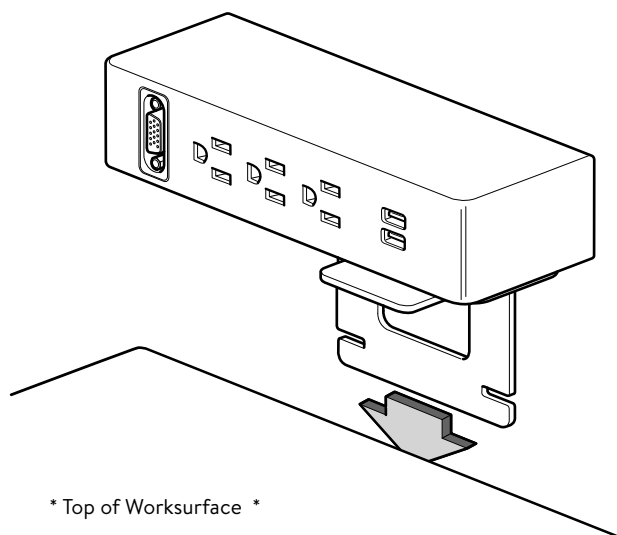

4 Install Bottom Bracket Under the Worksurface

* Underside of Worksurface *

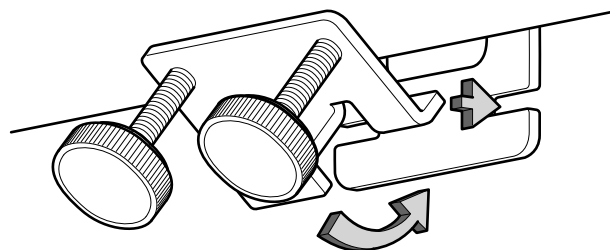

ASHLEY TRIO

- Corded -

Above Worksurface Mounting Installation Instruction

This device complies with part 15A of the FCC Rules. Operation is subject to the following two conditions: (1) This device may not cause harmful interference, and (2) this device must accept any interference received, including interference that may cause undesired operation.

Tools Required



NOTE

All Tech Adapters Need to be Mounted in the
↑ “UP” ↑ Position. (Refer to the back of Parts)

2.1 Install Data Tech Adapter Option

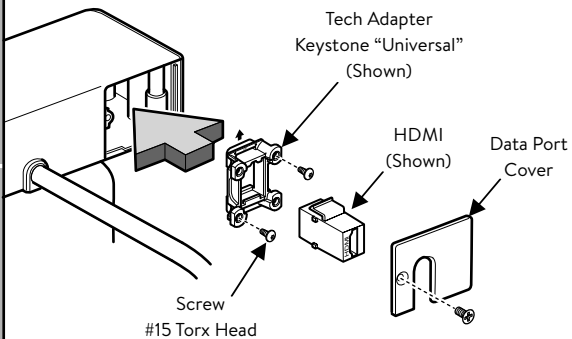

(Universal)

KEYSTONE

HDMI	Optical Cable Corp 5e
Tripp-Lite	Optical Cable Corp 6
Allen-Tel	Ortronics
AMP TE-Krone	Panduit NetKey
Belden KeyConnect	Hubbell Premise
Leviton Quick Port	Type F Coax
Leviton Quick Port Extreme	ETC. (ET. AL.)

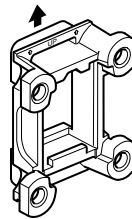

(Specific)
Belden EZ MDVO

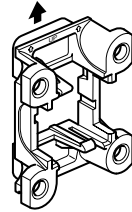

(Specific)
Panduit Mini-COM

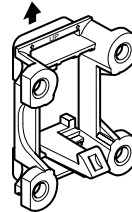

(Specific)
Commscope

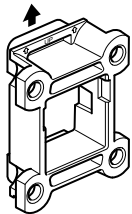

(Specific)
Ortronics TrackJack

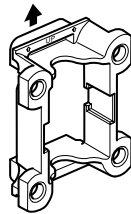

(Specific)
Simon

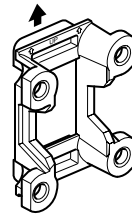

(Specific)
Cable Retainer

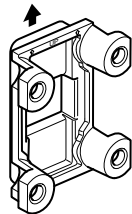

2.2 A Install VGA Connector to VGA Tech Adapters

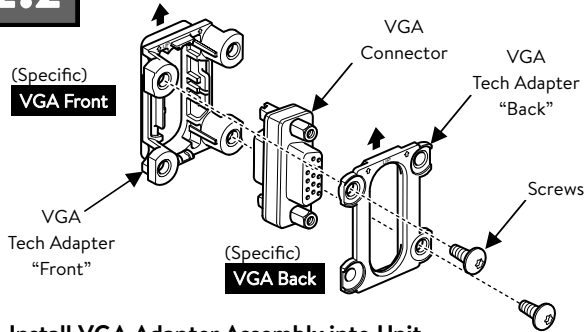

2.3 Install Blank Tech Adapter Option

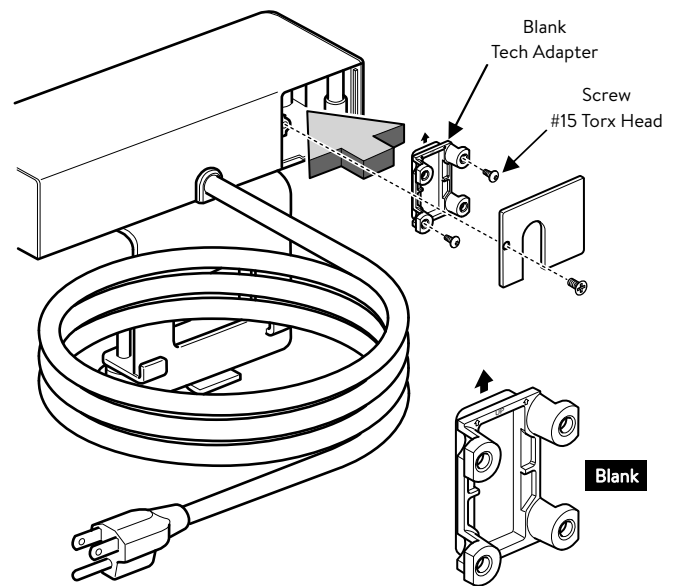

B Install VGA Adapter Assembly into Unit

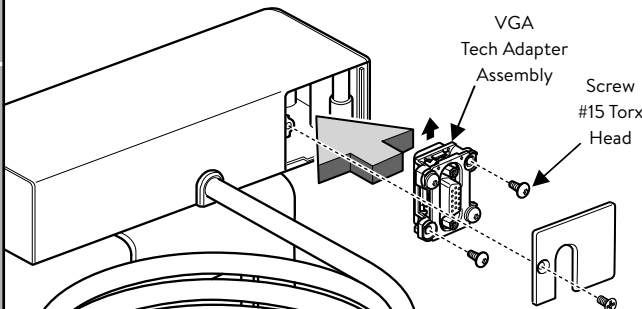

STUDIO

BY DEKKO

2505 Dekko Drive
Garrett, IN 46738
Customer Service: 800.357.5622

ASHLEY TRIO

- Corded -

Above Worksurface Mounting Installation Instruction

This device complies with part 15A of the FCC Rules. Operation is subject to the following two conditions: (1) This device may not cause harmful interference, and (2) this device must accept any interference received, including interference that may cause undesired operation.

Tools Required

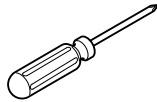

Screwdriver needed for optional power cord mounting clamps.

5

Secure Thumb Screws and Route Power Cord Option to Nearest Power Distribution Source

(A)

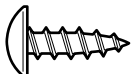

#8 x 1/2" Pan Head Screw

* Underside of Worksurface *

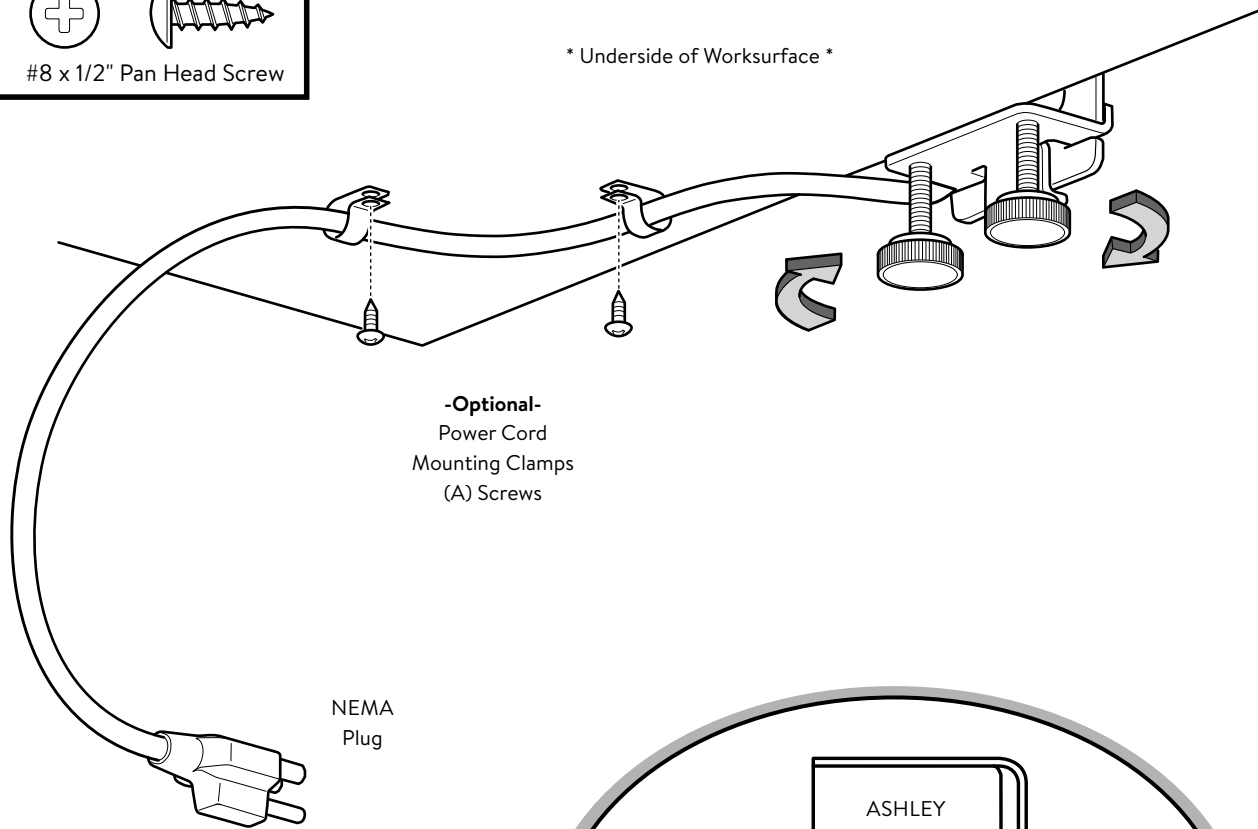

-Optional-
Power Cord
Mounting Clamps
(A) Screws

NEMA
Plug

Worksurface
Thickness Range
(3/4" to 1-1/2")

